



## About Warnings

 **WARNING:** A WARNING indicates a potential for property damage, personal injury, or death.

# Dell™ Vostro™ 420/220/220s Setup and Features Information

## Vostro 420 Front and Back View

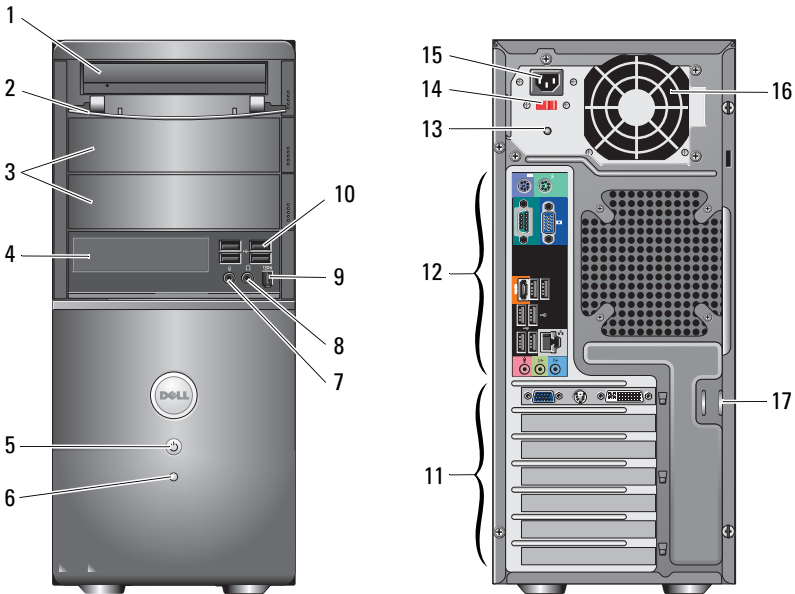

- |   |                                 |    |                              |
|---|---------------------------------|----|------------------------------|
| 1 | optical drive                   | 2  | drive bay front panel (open) |
| 3 | optional optical-drive bays (2) | 4  | media card reader (optional) |
| 5 | power button, power light       | 6  | drive-activity light         |
| 7 | microphone connector            | 8  | headphone connector          |
| 9 | IEEE 1394 connector (optional)  | 10 | USB 2.0 connectors (4)       |

January 2009



0J531HA02

Models: DCSCLF,  
DCSCMF, DCSCSF

- 11 expansion card slots (7)
- 12 back-panel connectors
- 13 power-supply light
- 14 voltage selector switch
- 15 power cord connector
- 16 power-supply vent
- 17 security cable/padlock rings

## Vostro 220 Front and Back View

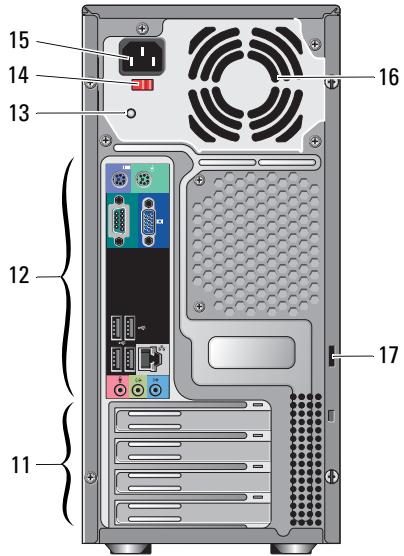
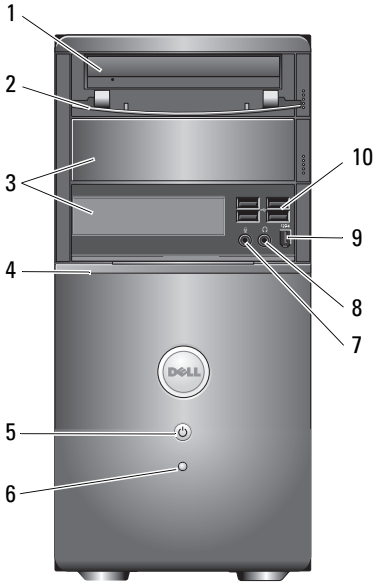

- 1 optical drive
- 2 drive bay front panel (open)
- 3 optional optical-drive bay
- 4 media card reader (optional)
- 5 power button, power light
- 6 drive-activity light
- 7 microphone connector
- 8 headphone connector
- 9 IEEE 1394 connector (optional)
- 10 USB 2.0 connectors (4)
- 11 expansion card slots (8)
- 12 back-panel connectors
- 13 power-supply light
- 14 voltage selector switch
- 15 power cord connector
- 16 power-supply vent
- 17 security cable/padlock rings

# Vostro 220s Front and Back View

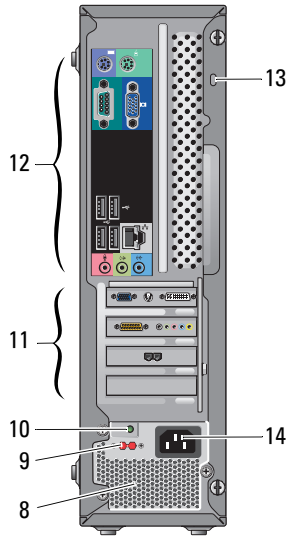
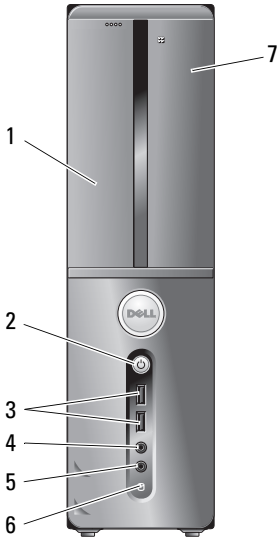

- 1 optical drive
- 3 USB 2.0 connectors (2)
- 5 microphone connector
- 7 media card reader (optional)
- 9 voltage selector switch
- 11 expansion card slots (4)
- 13 security cable/padlock rings

- 2 power button, power light
- 4 headphone connector
- 6 drive-activity light
- 8 power supply vents
- 10 power supply light
- 12 back-panel connectors
- 14 power connector

# Back Panel Connectors

## Vostro 420

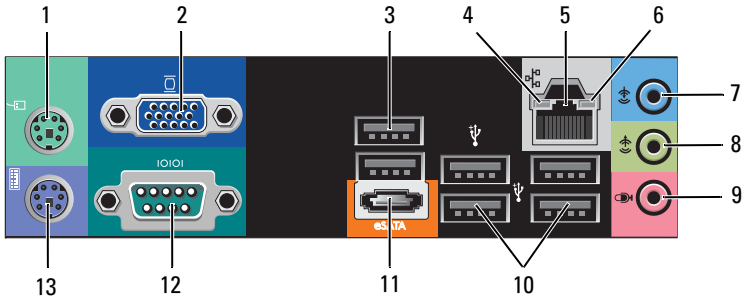

## Vostro 220/220s

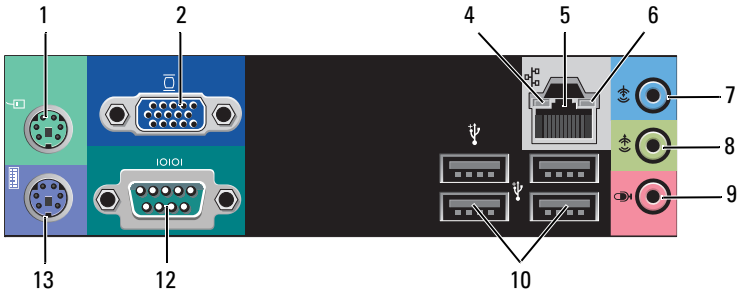

- 1 PS/2 mouse connector
- 2 VGA connector
- 3 USB 2.0 connectors (2)
- 4 link integrity light
- 5 network adapter connector
- 6 network-activity light
- 7 line-in connector
- 8 line-out connector
- 9 microphone connector
- 11 eSATA connector
- 13 PS/2 keyboard connector

- 2 VGA connector
- 4 link integrity light
- 6 network-activity light
- 7 line-in connector
- 8 line-out connector
- 10 USB 2.0 connectors (4)
- 12 serial connector (9-pin)

## Quick Setup

**⚠ WARNING:** Before you begin any of the procedures in this section, read the safety information that shipped with your computer. For additional best practices information see [www.dell.com/regulatory\\_compliance](http://www.dell.com/regulatory_compliance).

**📌 NOTE:** Some devices may not be included if you did not order them.

1 Connect the monitor using one of the following cables:

a The white DVI cable

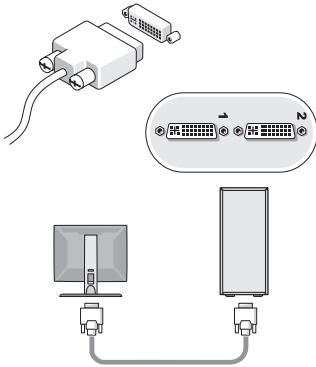

b The blue VGA cable

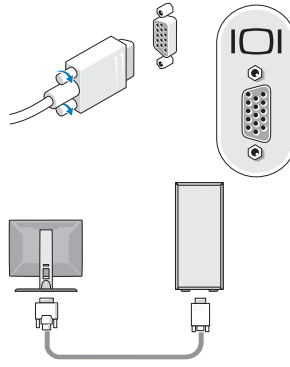

c The VGA cable to a DVI adapter

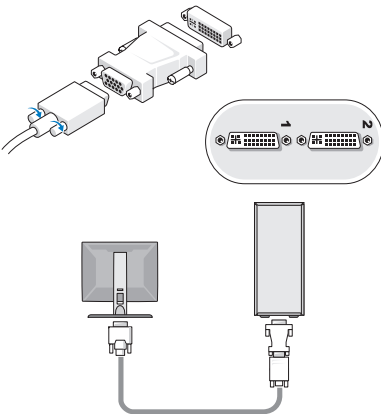

**2** Connect a USB device, such as a keyboard or mouse.

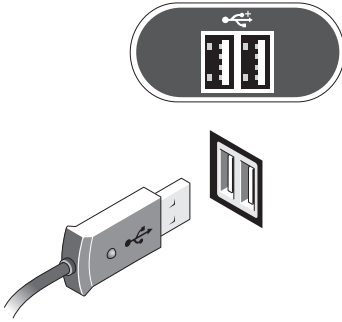

**3** Connect the network cable.

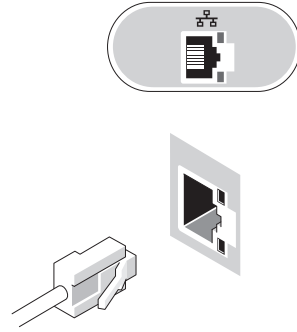

**4** Connect the modem.

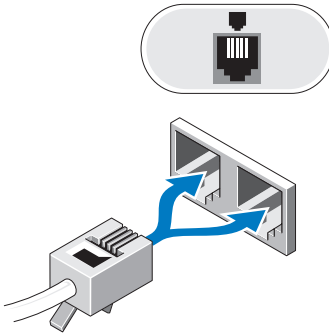

**5** Connect the power cable(s).

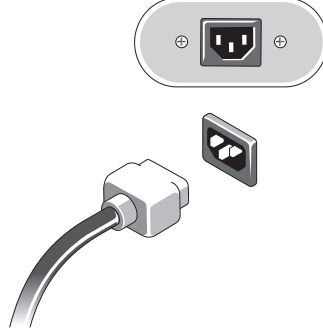

**6** Press the power buttons on the monitor and the computer.

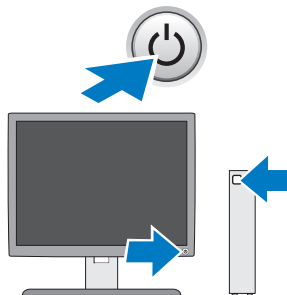

## Specifications



**NOTE:** The following specifications are only those required by law to ship with your computer. For a complete and current listing of the specifications for your computer, go to [support.dell.com](http://support.dell.com).

---

### Video

---

Type:

Integrated	Intel® GMA X4500HD
Discrete	supports dual independent displays <b>NOTE:</b> Support for discrete graphics option via PCIe x16 graphics card slot. <b>NOTE:</b> Supports Blu-Ray™ 1.1 playback and Dynamic Video Memory Technology (DVMT).

---

### Drives

---

Externally accessible:

5.25-inch Optical Disk Drives	Vostro 420 — three Vostro 220 — two Vostro 220s — one
media card reader (optional)	Vostro 420/220/220s — one

Internally accessible:

3.5-inch SATA drive bays	Vostro 420 — up to four Vostro 220/220s — up to two
--------------------------	--

**NOTE:** Internal and external drive bays accommodate standard 5.25-inch and 3.5-inch bay devices including HDD and short bay devices.

Available devices	3.5-inch SATA hard drives (80 GB to 1 TB optional) SATA DVD, SATA CD-RW/DVD Combo, SATA DVD+/-RW, SATA BD Combo (DVD RW + BD ROM), and SATA Blu-ray R/W 3.5-inch USB media card reader with optional Bluetooth® external USB floppy disk drive
-------------------	--

---

**Controls and Lights**

---

## Front of the computer:

Power button	push button
Power light	blue light — Blinking blue in sleep state; solid blue for power-on state amber light — Blinking amber indicates a power problem sensed by the power supply unit. Solid amber when the computer does not start indicates the system board cannot start initialization. off — System is in hibernate, soft-off, or mechanical-off
Drive activity light	blue light — A blinking blue light indicates the computer is reading data from or writing data to the SATA hard drive or CD/DVD.

## Rear of the computer:

Link integrity light (on integrated network adapter)	green light — A good connection exists between the network and the computer. off (no light) — The computer is not detecting a physical connection to the network.
Network activity light (on integrated network adapter)	yellow blinking light

---

**Power**

---

## DC power supply:

Voltage (see the safety information that shipped with your computer for important voltage setting information)	Vostro 420 — 115/230 VAC, 50/60 Hz, 8A/4A Vostro 220 — 115/230 VAC, 50/60 Hz, 7A/4A Vostro 220s — 115/230 VAC, 50/60 Hz, 6A/3A
Coin-cell battery	3 V CR2032 lithium coin cell

---

**Physical**

---

Height	Vostro 420 — 41.4 cm (16.3 inches) Vostro 220 — 35.44 cm (13.95 inches) Vostro 220s — 35.4 cm (13.9 inches)
Width	Vostro 420 — 18.3 cm (7.20 inches) Vostro 220 — 16.94 cm (6.67 inches) Vostro 220s — 10 cm (3.9 inches)



---

**Physical (continued)**

---

Depth	Vostro 420 — 48.2 cm (19.0 inches)
	Vostro 220 — 42.67 cm (16.8 inches)
	Vostro 220s — 41.5 cm (16.3 inches)
Weight	Vostro 420 — 11 kg – 13.8 kg (24 lb – 30.4 lb)
	Vostro 220 — 9.8 kg – 10.5 kg (22 lb – 23.1 lb)
	Vostro 220s — 7.98 kg – 8.9 kg (17.6 lb – 20 lb)

---

**Environmental**

---

## Temperature:

Operating 10° to 35° C (50° to 95° F)

Storage –40° to 65° C (–40° to 149° F)

Relative humidity 20% to 80% (noncondensing)

## Altitude:

Operating –15.2 to 3048 m (–50 to 10,000 ft)

Storage –15.2 to 10,668 m (–50 to 35,000 ft)

Airborne contaminant level G2 or lower as defined by ISA-S71.04-1985

---

---

**Information in this document is subject to change without notice.  
© 2008–2009 Dell Inc. All rights reserved. Printed in the U.S.A.**

Reproduction of these materials in any manner whatsoever without the written permission of Dell Inc. is strictly forbidden.

Trademarks used in this text: *Dell*, the *DELL* logo, and *Vostro* are trademarks of Dell Inc.; *Intel* is a registered trademark of Intel Corporation in the U.S. and other countries; *Bluetooth* is a registered trademark owned by Bluetooth SIG, Inc. and is used by Dell under license; *Blu-ray Disc* is a trademark of the Blu-ray Disc Association.

Other trademarks and trade names may be used in this document to refer to either the entities claiming the marks and names or their products. Dell Inc. disclaims any proprietary interest in trademarks and trade names other than its own.